



GST NO.: 29AHZPU5620Q1ZZ

An ISO 9001:2015 Certified Company

# ROYAL INDUSTRIAL SUPPLIERS

QUALITY FASTENERS SPECIALIST



8310165941 / 9959457863



sales@royalfastenersindia.com



www.royalfastenersindia.com

## TECHNICAL DATA SHEET

### CSK HEAD SLOTTED

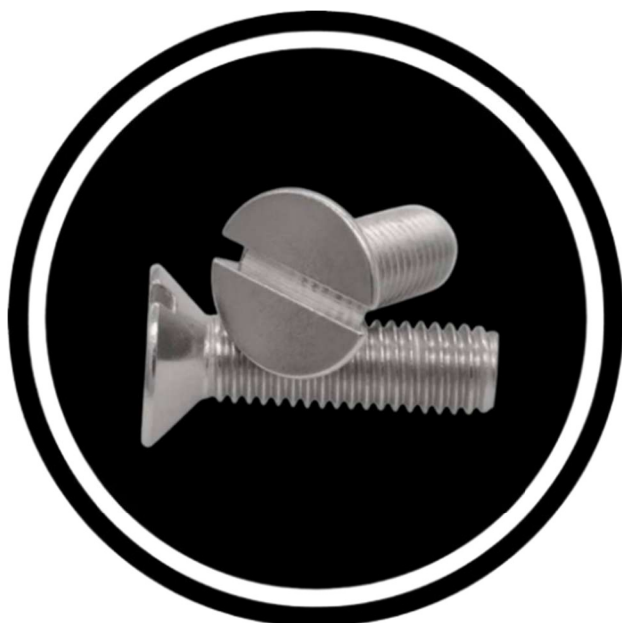

MATERIAL- STAINLESS STEEL

GRADE-SS316 (A4-70)

AS PER-DIN-963

CATALOGUE NO. R6B21

### INSTALLATION GUIDE

- SELECT THE CORRECT SIZE OF PAN HEAD SLOTTED SCREW AND MATCHING FLATHEAD SCREW DRIVER.
- CHECK THAT THE HOLE OR THREAD IS CLEAN AND FREE FROM DUST, OIL, OR DEBRIS.
- POSITION THE COMPONENTS IN PROPER ALIGNMENT BEFORE INSERTING THE SCREW.
- START THREADING THE PAN HEAD SLOTTED SCREW BY HAND TO AVOID CROSS THREADING.
- PLACE THE FLATHEAD SCREWDRIVER FIRMLY INTO THE SLOT OF THE SCREW HEAD.
- TURN THE SCREWDRIVER CLOCKWISE TO TIGHTEN THE SCREW.
- APPLY STEADY AND CONTROLLED FORCE TO PREVENT SLIPPING OR DAMAGING THE SLOT.
- DO NOT OVERTIGHTEN TO AVOID THREAD STRIPPING OR MATERIAL DAMAGE.
- USE A WASHER IF REQUIRED TO DISTRIBUTE LOAD AND PROTECT THE SURFACE.
- INSPECT THE FINAL INSTALLATION TO ENSURE THE PAN HEAD SLOTTED SCREW IS SECURE AND PROPERLY SEATED.

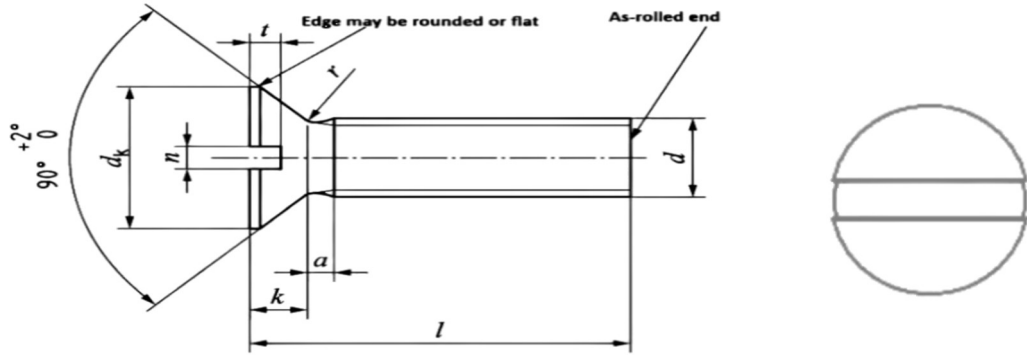

Parameter↓ Size→		M3x0.5	M3.5x0.6	M4x0.7	M5x0.8
Head Dia D	Max	6.50	7.50	9.20	11.00
	Min	6.14	7.14	8.84	10.57
Head Height k	Max	1.93	2.20	2.50	3.00
Slot width n		0.80	0.80	1.00	1.20
Slot Depth t max		0.85	1.00	1.10	1.30

Quote the PART NUMBER given below with your order/ inquiries:

All Dimensions in mm

Length↓	Size→	M3x0.5	M3.5x0.6	M4x0.7	M5x0.8
3		R6B2103003			
4		R6B2103004			
5		R6B2103005	R6B2130505	R6B2104005	
6		R6B2103006	R6B2130506	R6B2104006	R6B2105006
8		R6B2103008	R6B2130508	R6B2104008	R6B2105008
10		R6B2103010	R6B2130510	R6B2104010	R6B2105010
12		R6B2103012	R6B2130512	R6B2104012	R6B2105012
14		R6B2103014	R6B2130514	R6B2104014	R6B2105014
16		R6B2103016	R6B2130516	R6B2104016	R6B2105016
18		R6B2103018	R6B2130518	R6B2104018	R6B2105018
20		R6B2103020	R6B2130520	R6B2104020	R6B2105020
22		R6B2103022	R6B2130522	R6B2104022	R6B2105022
25		R6B2103025	R6B2130525	R6B2104025	R6B2105025
28		R6B2103028	R6B2130528	R6B2104028	R6B2105028
30		R6B2103030	R6B2130530	R6B2104030	R6B2105030
35		R6B2103035		R6B2104035	R6B2105035
40		R6B2103040		R6B2104040	R6B2105040
45		R6B2103045		R6B2104045	R6B2105045
50		R6B2103050		R6B2104050	R6B2105050
55		R6B2103055		R6B2104055	R6B2105055
60		R6B2103060		R6B2104060	R6B2105060
65		R6B2103065		R6B2104065	R6B2105065
70		R6B2103070		R6B2104070	R6B2105070
75		R6B2103075		R6B2104075	R6B2105075
80		R6B2103080		R6B2104080	R6B2105080
90		R6B2103090		R6B2104090	R6B2105090
100		R6B2103100		R6B2104100	R6B2105100

Sizes in BLUE are non-preferred. Availability is limited and MOQ is applied. *Data is strictly informative*

Note: All Austenitic Stainless-Steel Fasteners may exhibit some Magnetic Properties due to the Manufacturing Process.

Refer: ISO 3506-2 Annex F

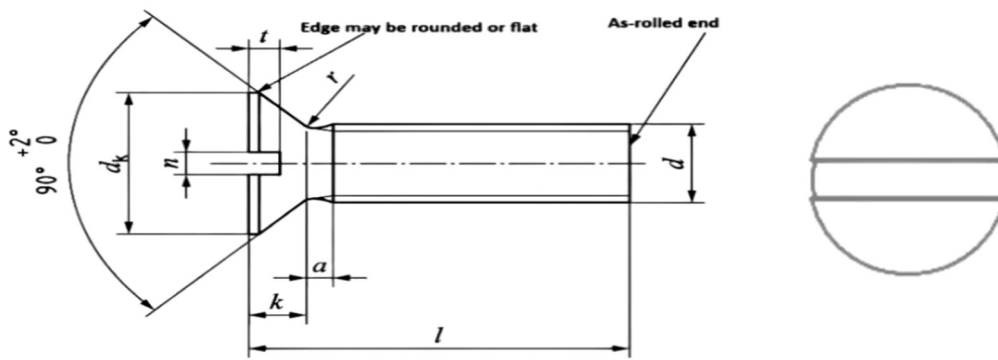

Parameter↓ Size→		M6x1.0	M8x1.25	M10x1.5	M12x1.75
Head Dia D	Max	14.50	18.00	22.00	5.60
	Min	14.07	17.57	21.48	5.30
Head Height k	Max	4.00	5.00	6.00	1.65
Slot width n		1.60	2.00	2.50	3.00
Slot Depth t max		1.60	2.10	2.60	3.00

Quote the PART NUMBER given below with your order/ inquiries:

All Dimensions in mm

Length↓	Size→	M6x1.0	M8x1.25	M10x1.5	M12x1.75
8		R6B2106008			
10		R6B2106010	R6B2108010		
12		R6B2106012	R6B2108012		
14		R6B2106014	R6B2108014		
16		R6B2106016	R6B2108016	R6B2110016	R6B2112016
18		R6B2106018	R6B2108018	R6B2110018	R6B2112018
20		R6B2106020	R6B2108020	R6B2110020	R6B2112020
22		R6B2106022	R6B2108022	R6B2110022	R6B2112022
25		R6B2106025	R6B2108025	R6B2110025	R6B2112025
28		R6B2106028	R6B2108028	R6B2110028	R6B2112028
30		R6B2106030	R6B2108030	R6B2110030	R6B2112030
35		R6B2106035	R6B2108035	R6B2110035	R6B2112035
40		R6B2106040	R6B2108040	R6B2110040	R6B2112040
45		R6B2106045	R6B2108045	R6B2110045	R6B2112045
50		R6B2106050	R6B2108050	R6B2110050	R6B2112050
55		R6B2106055	R6B2108055	R6B2110055	R6B2112055
60		R6B2106060	R6B2108060	R6B2110060	R6B2112060
65		R6B2106065	R6B2108065	R6B2110065	R6B2112065
70		R6B2106070	R6B2108070	R6B2110070	R6B2112070
75		R6B2106075	R6B2108075	R6B2110075	R6B2112075
80		R6B2106080	R6B2108080	R6B2110080	R6B2112080
90		R6B2106090	R6B2108090	R6B2110090	R6B2112090
100		R6B2106100	R6B2108100	R6B2110100	R6B2112100
120		R6B2106120	R6B2108120	R6B2110120	R6B2112120
130			R6B2108130	R6B2110130	R6B2112130
140			R6B2108140	R6B2110140	R6B2112140
150			R6B2108150	R6B2110150	R6B2112150

Sizes in BLUE are non-preferred. Availability is limited and MOQ is applied. *Data is strictly informative*

Note: All Austenitic Stainless-Steel Fasteners may exhibit some Magnetic Properties due to the Manufacturing Process.

Refer: ISO 3506-2 Annex F