

## Expandet Spring Toggle Anchor

Expandet Spring Toggle Anchor is suitable for light duty fixings in ceilings and provides the possibility for bridging thick walls. Especially suitable for fixing of suspended ceilings, brackets, cable trays, pipings etc.

Expandet Spring Toggle is zinc plated min. 5 µm.

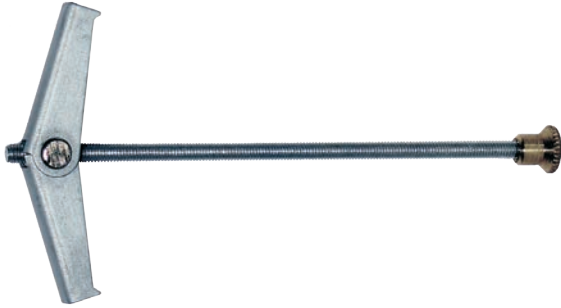

**PLASTERBOARD**

### ADVANTAGES

- Capable of bridging thick walls.
- Suitable in all materials with cavities.
- Useable with all metric threaded screws.

### INSTALLATION:

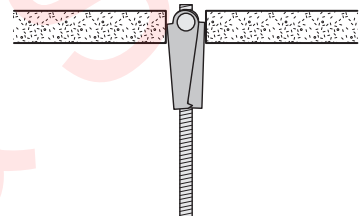

1]

Drill a hole through the material. Use HSS-drill in plasterboards and other porous materials. Insert the Spring Toggle Anchor through the drilled hole. The toggle-wings will jump into place in the cavity.

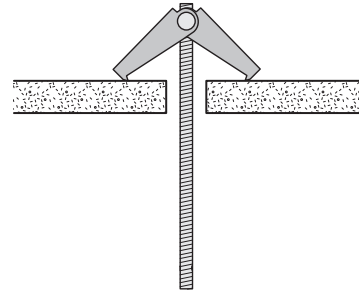

2]

Place the fixture and tighten the nut. Avoid over-tightening the Spring Toggle Anchor to prevent damaging the board.

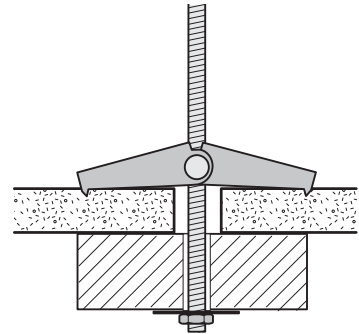

3]

The installation is finished

Type	Load capacities
DIMENSION	$N_{rec}$
	Recommended tension load i 13 mm Plasterboard kN*
With nut and washer	
3 x 85	0,20
4 x 90	0,25
With hook	
3 x 70	0,03
4 x 70	0,10
With cap nut	
3 x 85	0,20
4 x 90	0,25

\* Loads are recommended maximum in plasterboards with 300 mm spacing between each Spring Toggle Anchor. Safety factor is included ( $\geq 3$ ). 1 kN  $\approx$  100 kg.

**NB:** Is the recommended spacing not applied the load-capacity will be reduced..

# Expandet Spring Toggle Anchor

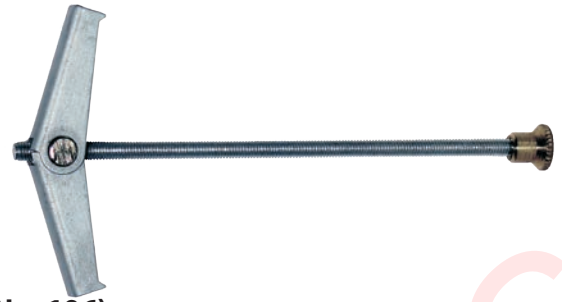

## EXPANDET SPRING TOGGLE ANCHOR (Technical Sheet No. 106)

TYPE DIMENSION	CAVITY (MIN.) MM	DRILL DIA. MM	LENGTH OF SCREW MM	MATERIAL AND THICKNESS OF FIXTURE (MAX.) MM	EXPANDET ARTICLE NO.	PCS. PER BOX	Part No	EAN 13 PER BOX
<b>WITH NUT AND WASHER</b>								
M3 x 85	28	12	85	60	903085 M	50	<a href="#">N1L0703085</a>	5708620099880
M4 x 90	35	14	90	65	904090 M	50	<a href="#">N1L0704090</a>	5708620099897
<b>WITH HOOK</b>								
M3 x 70	28	12	70	30	903070 K	50	<a href="#">N1L0803070</a>	5708620099866
M4 x 70	35	14	70	30	904070 K	50	<a href="#">N1L0804070</a>	5708620099873
<b>WITH CAP NUT</b>								
M3 x 85	28	12	85	60	903085 T	50	<a href="#">N1L0803085</a>	5708620099903
M4 x 90	35	14	90	65	904090 T	50	<a href="#">N1L0804090</a>	5708620099910

PLASTERBOARD



Hook

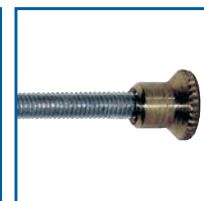

Cap Nut

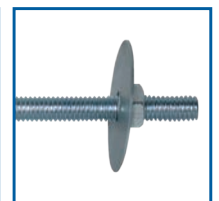

Nut/  
Washer